

Varenummer: 0106052
 Beskrivelse: Seeger låsering JV 35

Mål

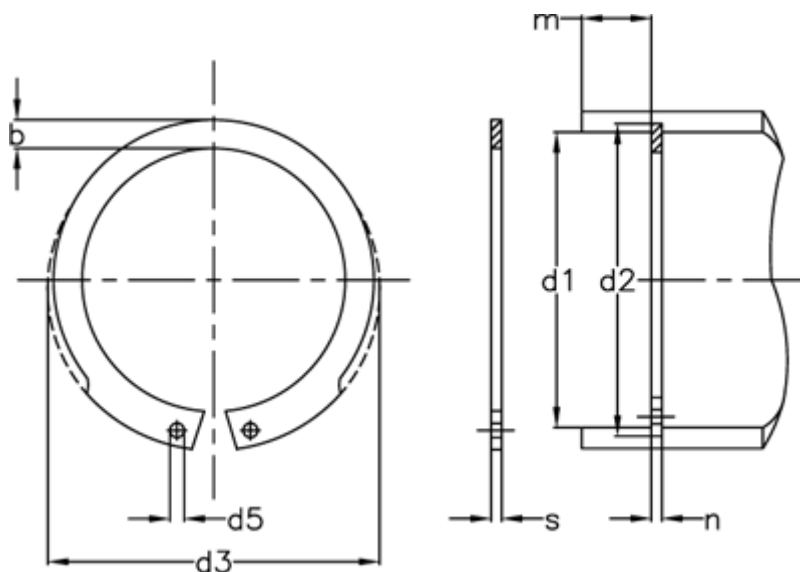

AN mm ²	= 55	FRg kN	= 6.3	Tang	= ZGJ-1
b	= 3.4	FR kN	= 26.4	tol	= -0.06
Betegnelse	= JV 35	g	= 1.5	tol	= +0,50-0,25
d1	= 35	K kN-mm	= 49.6	tol	= +0,25
d2	= 37.0	m min	= 1.60	tol	= 0.1
d3	= 37.8	Nominel træk	= 3.0	vægt kg/1000	= 3.20
d5 min	= 1.7	s	= 1.50		
FN kN	= 9.20	t	= 1.00		